

ACTIVE VIBRATION ISOLATION SYSTEM

AVI-600 LP

Instruction Manual

AVI-600S LP, AVI-600M LP, AVI-600XL LP

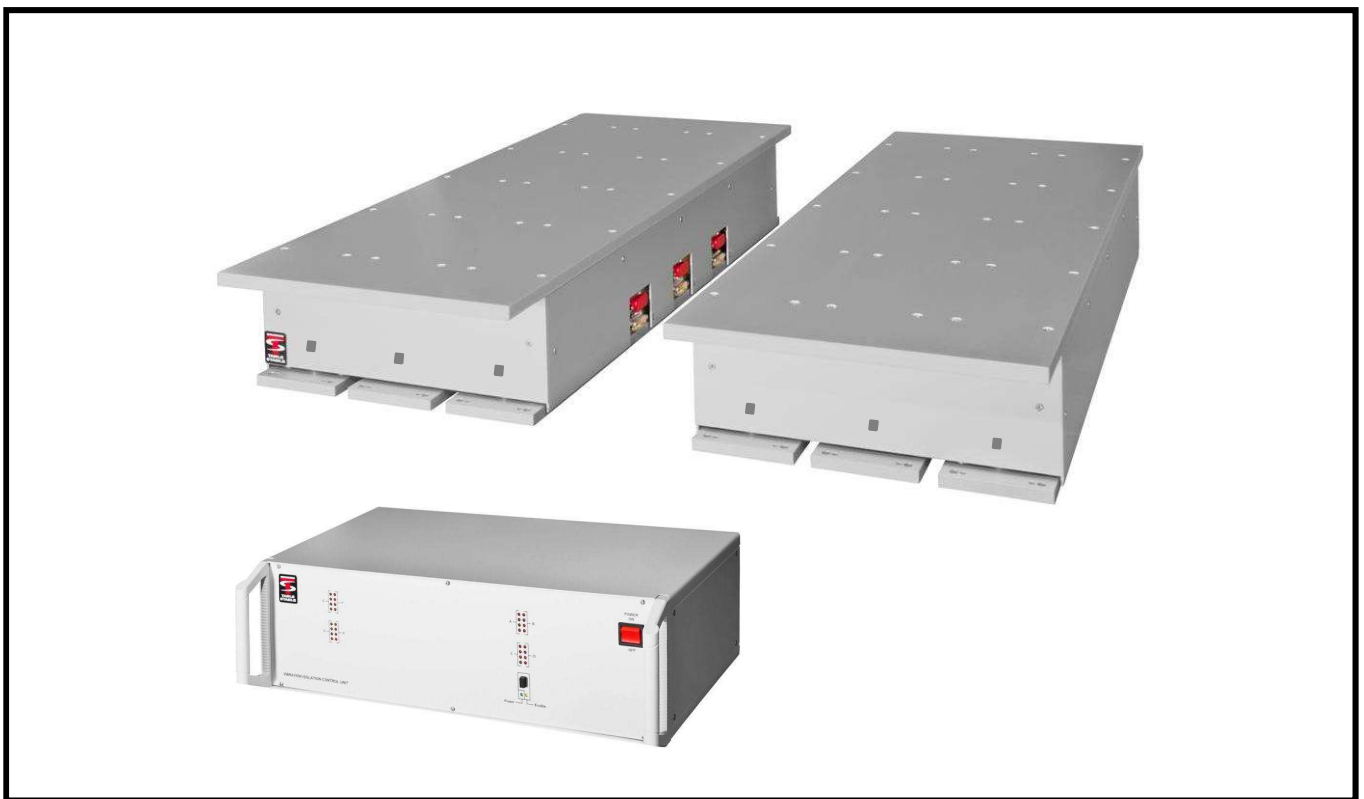

The TableStable Ltd.
Im Grindel 6
8932 Mettmenstetten
Switzerland

Phone: +41 (0)44 776 33 66
Fax: +41 (0)44 776 33 65
E-mail: info@tablestable.com
Internet: www.tablestable.com

Vibration isolation technology made in Switzerland



Table of contents

<i>Safety Instructions</i>	4
<i>Notes on equipment safety</i>	4
<i>Cleaning the outside of the system</i>	4
<i>Accessories</i>	4
<i>General</i>	5
<i>Optimum support surface</i>	6
<i>Table top</i>	6
<i>System setup</i>	7
<i>Adjustment for change of load</i>	8
<i>Checking the correct load compensation</i>	9
<i>Operation</i>	10
<i>Test of support surface</i>	10
<i>Control unit</i>	11
<i>Pin layout for rear D-Sub sockets</i>	12
<i>Fuses</i>	12
<i>Diagnostic output</i>	13
<i>Sensor axis layout</i>	13
<i>Installation checklist</i>	14
<i>Troubleshooting</i>	15
<i>Transmissibility</i>	16
<i>Dimensions AVI-600S LP</i>	17
<i>Dimensions AVI-600M LP</i>	18
<i>Dimensions AVI-600XL LP</i>	19
<i>Optional accessories</i>	20
<i>Sales offices</i>	21
<i>Service order</i>	21
<i>Specifications AVI-600 LP</i>	22

Safety Instructions

The system may only be plugged into a socket with separate ground. Do not disconnect this ground, either at the socket, or by using an ungrounded extension cable.

If you suspect the system to be in any way unsafe, unplug and prevent any possible accidental usage. Contact your nearest service centre.

Before switching on this apparatus make sure that it is connected to the correct mains voltage. Do not remove any cover or allow any metal objects to enter the ventilation slits.

Disconnect from mains before removing any covers. Refer servicing to qualified personnel.

Do not use in potentially explosive surroundings.

The fuses are located in the power socket on the rear side of the control unit. Do not attempt to change a fuse without first unplugging from the mains. Only replace a fuse with the correct type. Never try to bypass a fuse.

Make sure the ventilation slits in the control unit are not covered and that air can freely circulate. Blocking the slits can lead to overheating which could cause a fire.

For connection between the control unit and the isolation elements use only the D-Sub 15 cable (m/f) provided.

Notes on equipment safety

This system has been designed, manufactured and tested in conformity to the following community Directives/Regulations and Standards:

2014/35/EU : Low Voltage Directive (LVD)

Standard : EN61010-1:2010; EN61010-2-030:2010; EN61010-2-033:2012

2014/30/EU: Electromagnetic Compatibility Directive (EMC)

Standard : EN55011:2009/2010; EN61326-1:2013; EN61326-2-1:2013; EN61326-2-2:2013

2011/65/EU+2015/863/EU+2017/2102/EU: RoHS directive.

The operator should read this manual which contains important warnings and information.

Cleaning the outside of the system

Use neutral detergents. Cleaning with solvents will damage the outside surface of the system.

Do not use cleaning materials that contain ammonia.

Do not use isopropyl alcohol to remove dirt from the control panel. It may crack the panel.

Do not use flammable substances or any type of spray to clean the system.

Accessories

- 1 Hex Key 2mm
- 1 Spanner 10mm
- 1 Setting gauge 13mm
- 1 Power Cable
- 6 D-Sub 15 Cables 5m
- 1 Instruction Manual

Thank you...

...for your purchase of the **AVI active vibration isolation system**. This system has been designed specifically with performance and ease of use in mind. As with all Table Stable products, this system is made to the highest quality standards using precision electronics and mechanical components which should give you many years of trouble free use. Please read this instruction manual carefully before use to ensure you get the best out of your new isolation system.

General

This moderately priced dynamic vibration isolation system achieves in a very small volume better isolation than is possible with the biggest and most expensive passive systems. Inertial feedback is used via force transducers to provide not only isolation from building vibrations, but also isolation from vibration sources placed on the system itself. This means, for example, that a delicate microscope isolated by the system will remain at rest despite forces being applied via the operator's hands.

The inherent stiffness of the system, some 200-500 times greater than that of a 1 Hz resonance passive isolator, imparts excellent directional and positional stability.

The lack of any low frequency resonance, a resonance which plagues all passive systems, allows the systems to be stacked for super-isolation in severe environments.

AVI-600 LP is an adaptable system consisting of two modules and is ideal for supporting delicate Fabry-Perot interferometers and tunnel-microscopes, allowing the ultimate performance to be achieved from these and other high resolution instruments. The tables have also proved to be extremely successful for supporting sensitive experiments, such as the troughs for liquids used in measurements on Langmuir-Blodgett films.

Each module by itself isolates against vertical and horizontal translations and against rotations about one horizontal axis. The combination of two modules isolates against all six possible translational and rotational vibrations.

Isolation of the standard AVI-600 LP system begins at about 2 Hz, increasing rapidly to at least 35dB beyond 10 Hz. This system offers excellent isolation in the typical laboratory environment.

The modules cannot be used separately.

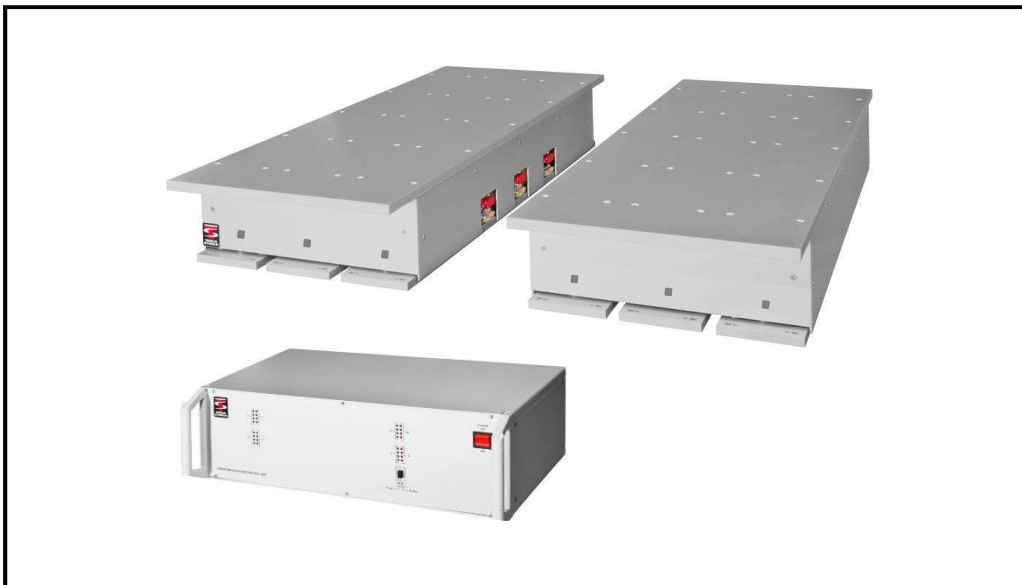

Optimum support surface

To obtain the optimum performance from the system it must be supported on a surface which is as rigid as possible. The best possible is to put AVI-600 LP directly on the floor. However for most applications this will not be practical, and some support structure will be required to bring the system to a convenient operating height. Most simple table structures will be rigid enough vertically, but will leave much to be desired horizontally. The addition of diagonal struts between the table legs can improve the situation dramatically.

It is good to bear in mind that any support structure will follow the building vibrations exactly up to some certain cut off frequency at which point the structure goes into resonance and amplifies the vibration amplitudes. A good structure will have its lowest resonance frequency well above 100 Hz.

It is an unfortunate fact of life that the amplitudes of the vertical vibrations of the building (dominantly bending modes of the floor) are largest in the centre of the floor, where for convenience most experiments are situated!

Since the table AVI-600 LP is quite small a possible location may be on a shelf attached to a building pillar. Good braces will be required to support the shelf. This location has the advantage that the vertical vibrations of the building will be very much reduced.

Table top

The table top must be sufficiently stiff to prevent a relative rotation of the two isolation units about their long horizontal axes. A honeycomb breadboard or an aluminium plate 30mm thick will give best results, but stone plates or even solid wooden boards may be used.

For the positions of the attachment holes, see the drilling plan at the end of this document.

Note that it is also possible to attach the isolation units directly to the supported equipment. In this case a rigid mounting is absolutely essential. We will be happy to advise you on the best mounting method.

The units should be arranged parallel to each other and may be spaced any distance from each other provided that the top plate is sufficiently rigid.

Recommended size for table top

AVI-600S LP	800 × 500 mm
AVI-600M LP	1400 × 800 mm
AVI-600XL LP	1600 × 1000 mm

Material: Solid aluminium or granite 2-3 cm thick or thick honeycomb material.

Attaching table top

Lower the table top gently into position and slide until the attachment holes in the table top align with the holes in the isolation units. Attach each unit securely with bolts.

Do not under any circumstances be tempted merely to rest the table top without screws on the isolation units. This is guaranteed to give poor results.

System setup

The units should be placed with the cables to the inside as shown in Fig. 1

Note: To ensure low frequency stability the distance between the units should be no less than 600mm.

Connect the **lower** D-Sub socket (1) of the isolation units to the control unit: **A to A** and **B to B** etc.

Note: All output sockets on the control unit have the same properties and can be connected to any unit. However for correlating the front panel LEDs with the individual axes (see page 13) the individual AVI units will be defined by the socket too which they are attached.

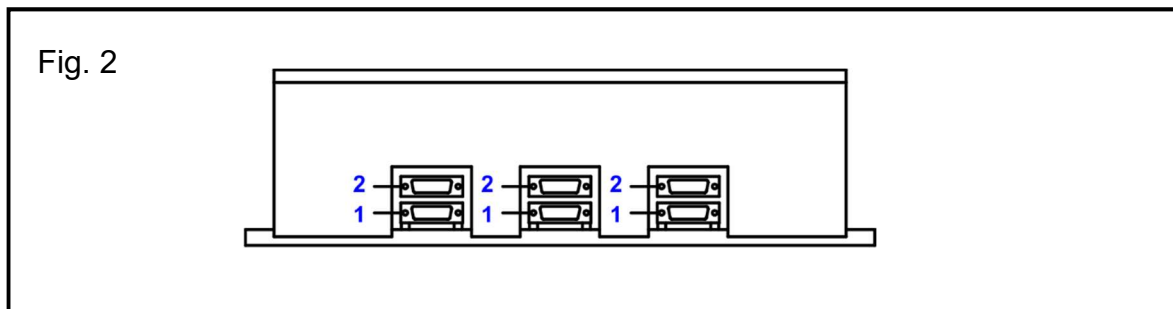
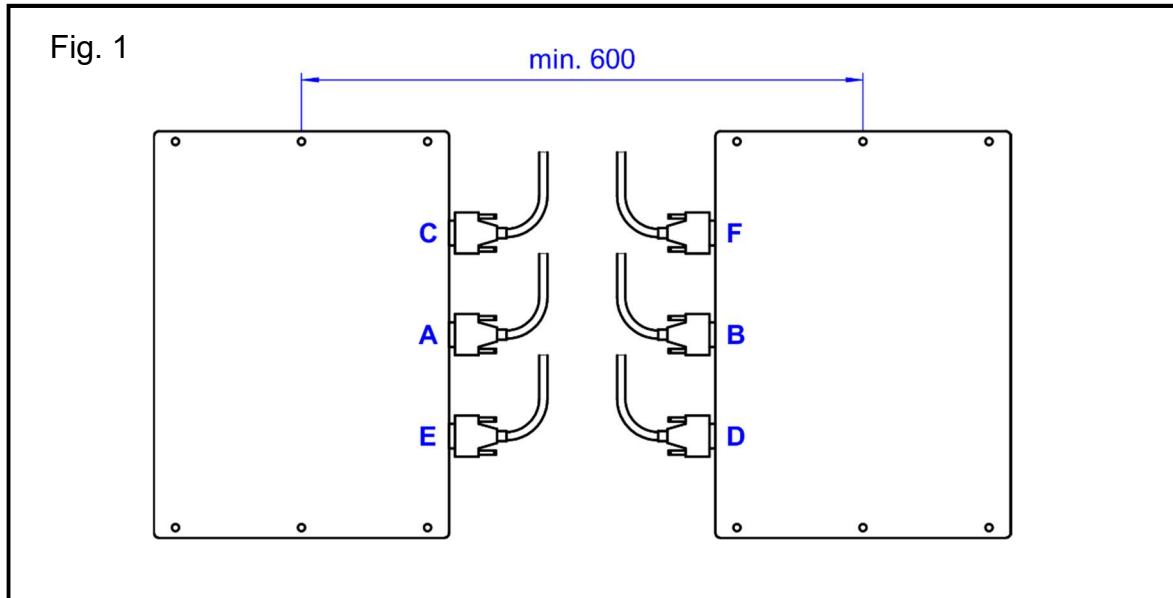

Diagnostic socket (2)

This socket is for testing, exciting and diagnostic purposes. **Do not connect to the controller!** A modulation signal can also be applied at this Input.

Pin layout for the D-Sub 15 diagnostic socket

1	A1 (ICC)	6	GND	11	GND
2	Test out H1	7	-8V	12	Test in V2
3	Test out V1	8	SDA	13	Test in H2
4	Test in V1	9	Test out H2	14	+8V
5	Test in H1	10	Test out V2	15	SCL

Adjustment for change of load

Each unit of AVI-600 LP can be adjusted to accommodate loads in the range 0 to 600kg. For any setting the load on the system consisting of two units, may be varied **+/- 90kg** without having to reset the adjustments.

To expose the adjustment nuts, remove the end covers by undoing the screws shown in Fig. 3 (2mm hex key).

Fig.3

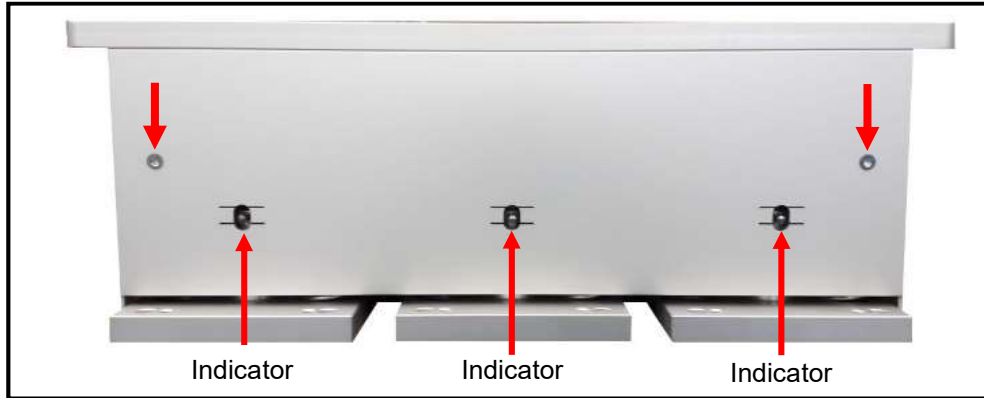

Under load the upper gap and the lower gap shown in Fig. 4 should be approximately equal. (It is however not essential that the gaps be equal - either gap may be as small as 0.5mm without affecting normal operation, but a small subsequent change of load might cause the unit to move against the stop).

Fig. 4



If an adjustment is needed turn the M6 nuts using the spanner provided. Adjust all springs on both sides equally. Moving the spanner to the left raises the units. Use the setting gauge provided to adjust the springs to a gap of max. 13mm. Do not turn the nuts too far or you may damage the units. Under no circumstances should the gap be greater than 13mm.

Fig. 5

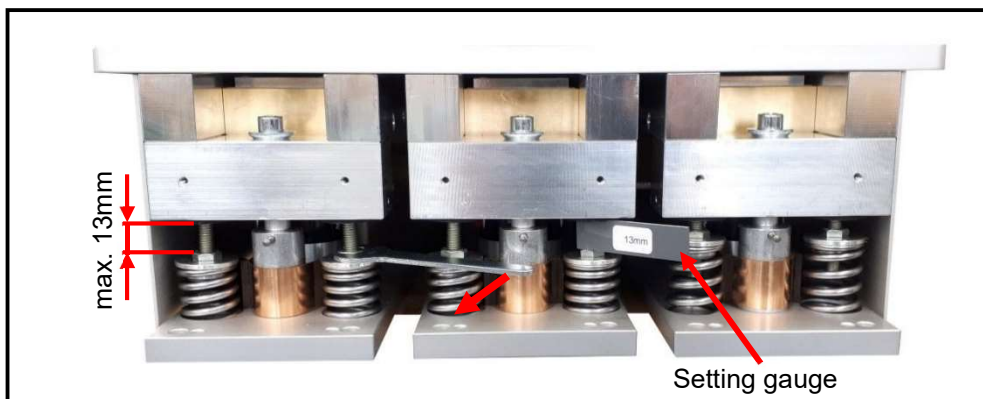

Checking the correct load compensation

Indicators are located on the end plates (Fig. 3) of the AVI series so that a simple visual inspection will show if the system is correctly floating.

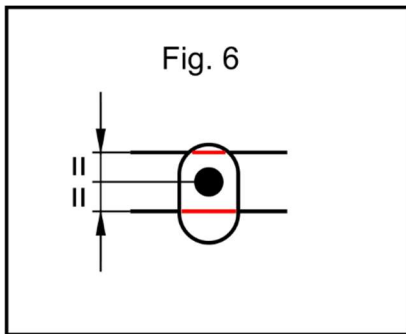
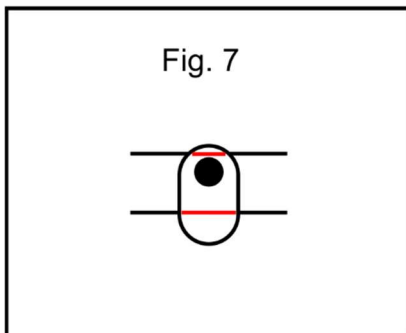
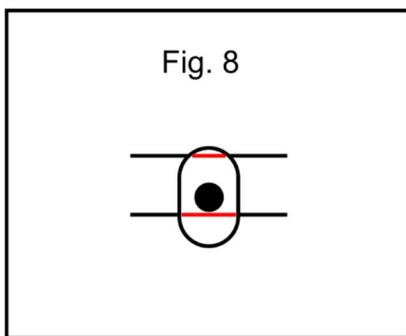

Figure 6 shows the optimum adjustment where the pin is situated **midway** between the two lines.



When the pin is just tangential to the lines as shown in figures 7 and 8 the system is still floating but with only 0.5mm free movement, downwards or upwards respectively. In this case a small change in load could prevent the system from floating freely.



If a correction is needed the end plate must be removed and adjustment carried out in the normal manner. The end plate can be temporarily held in place to check the adjustment. Finally the plate can be re-attached.

Operation

When operating the system for the first time, set the front panel isolation switch to OFF (black knob out). Switch on the power. The power indicator lamp will now light and the 24 display LEDs will briefly flicker. The yellow enable LED will flash on and off at about 2 Hz. If severe vibrations are present or if you place your hand on the table top, some or all of the LEDs will flicker.

About 30 seconds after switching on the power, you may push the isolation switch to ON position (black knob in).

The yellow LED will now stay permanently on, indicating that the system is isolating.

Place a hand gently on the table top. Probably one or more LEDs will come on, indicating an overload. Learn how much force may be applied without causing an overload. If you now apply a lot of force to the table top, all overload lamps will come on and the **isolation indicator lamp will flash** for a few seconds, indicating that the system is temporarily no longer isolating until the overload is removed (**standby mode**).

After removing the overload, the isolation lamp should come on again, and the system begins to isolate. Some overload LEDs may come on and persist for a few seconds. Even during this stage the system is isolating - but at reduced gain. After a severe overload the system may take half a minute to reach full isolation, but normally only a few seconds is required.

NOTE: In normal use the isolation switch may be left in the ON position (black knob in). On switching on the power, the yellow lamp will at first flash, indicating the system is in the standby mode. After about 30 seconds the lamp stops flashing and stays on, indicating that the system is now isolating.

Test of support surface

With the system operating, push on the support surface. The overload lamps should not light up except possibly for a severe push. If the lamps can easily be made to light up, then the support surface is not sufficiently rigid to obtain full performance. Ascertain whether the support surface reacts more to horizontal or vertical forces and try to stiffen the structure appropriately.

Note that the system will operate on any support surface, but a soft structure resonantly amplifies certain building vibration frequencies and these will therefore be less effectively isolated.

Control unit

The control unit provides the power for driving the modules. Typically power consumption is less than 22W, rising to 28W in extreme environments. The control unit has an input which may be connected to an AC power point of 100-120/200-240VAC, 50-60Hz

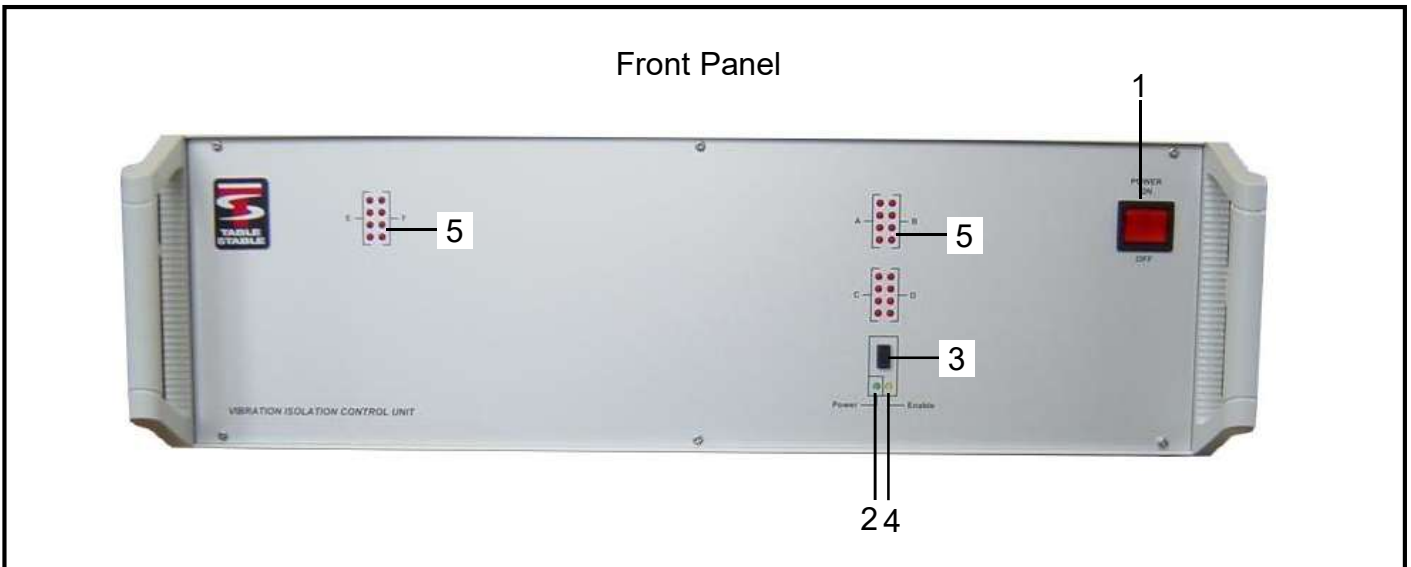

- 1 Power switch
- 2 Power indicator
- 3 Isolation enable switch
- 4 Isolation enable indicator
- 5 Input stage overload Indicator

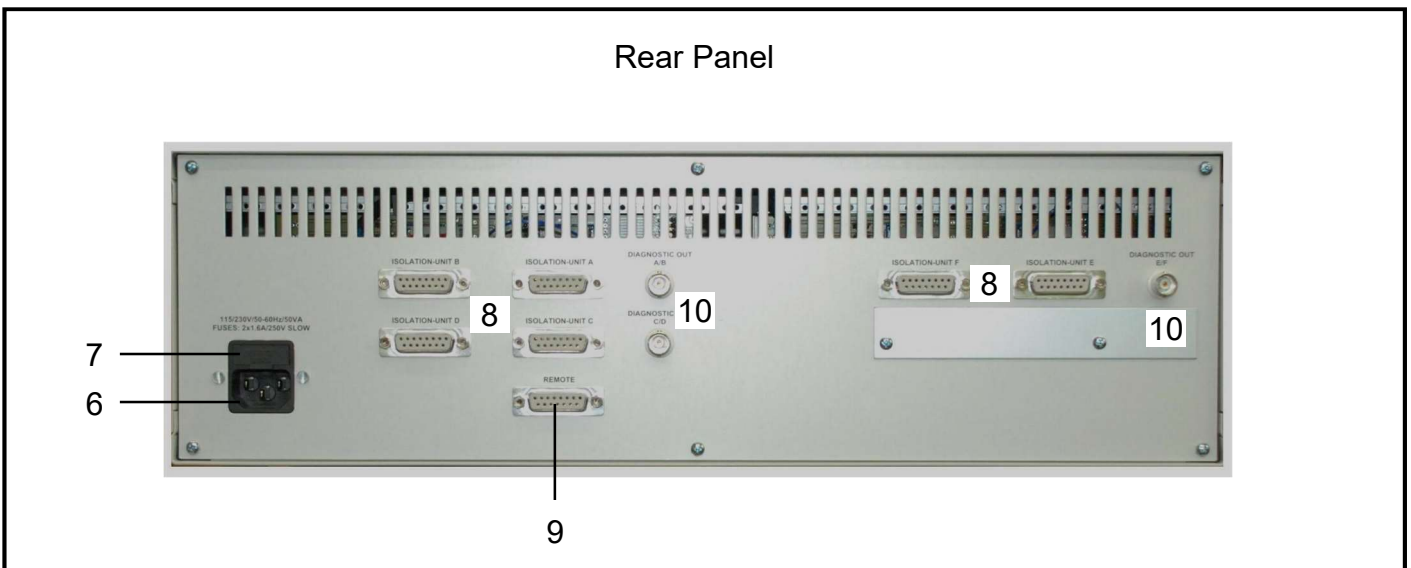

- 6 Power socket
- 7 Fuses
- 8 Output sockets
- 9 Remote socket
- 10 Diagnostic output

Pin layout for rear D-Sub sockets

Output sockets (8)

1 +60V	6 GND	11 Enable
2 -60V	7 GND	12 Test out V2
3 +8V	8 GND	13 Test out H2
4 Test out V1	9 GND	14 GND
5 Test out H1	10 -8V	15 GND

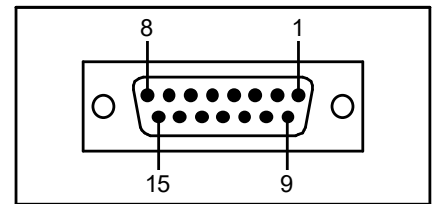

Remote socket (9)

1	6	11 ext. disable indicator
2 RXD	7	12
3 TXD	8	13
4 -8V	9 +8V	14
5 GND	10 ext. disable	15

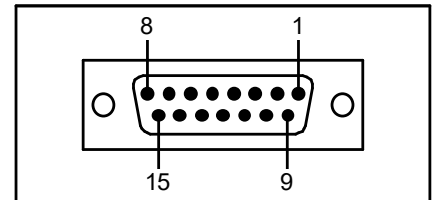

External isolation on/off switching:

This offers a **DISABLE** function.

The system must first be enabled via the enable button on the control unit. Subsequently the system may be disabled by joining pin 10 to pin 9. When pin 10 is floating the system will be enabled again.

An optional **remote box** can also fulfil this function (page 20).

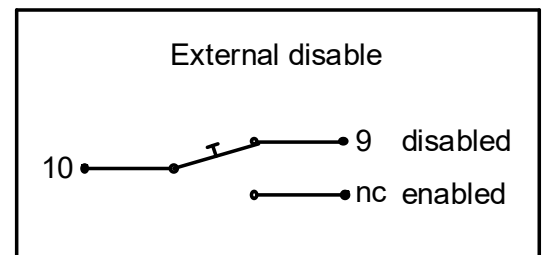

Indicator:

An LED with a 470 ohm resistor in series may be connected between pin 11 and pin 5 to give an indication when the system is enabled.

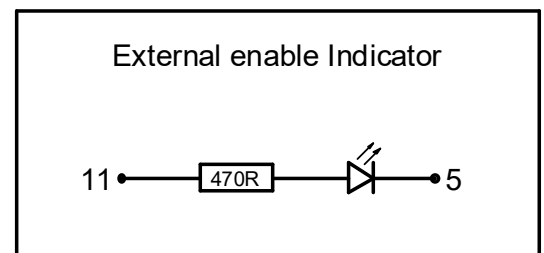

Fuses

The fuses are located in the power socket on the rear side of the control unit. **2×1.6A/250V slow.**

Do not attempt to change a fuse without first unplugging from the mains.

Only replace a fuse with the correct type.

Never try to bypass a fuse.

Diagnostic output

Each rear panel BNC socket (A/B, C/D, E/F) gives a multiplexed output showing the signals from 8 accelerometers. To view this signal on an oscilloscope, set the time base to **20msec** and the sensitivity to **0.1V/division**.

On using the system for the first time it is strongly recommended that you observe this signal, with the isolation switch both ON and OFF - it gives a good impression of how well the system is operating.

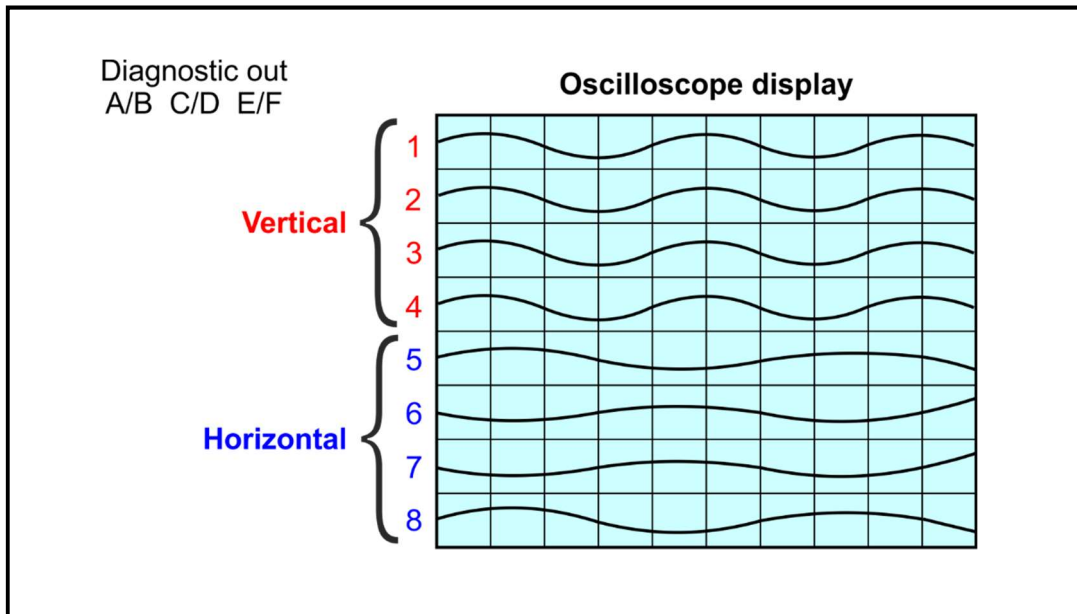

Sensor axis layout

Diagram below shows the correspondence between the front panel LEDs and the individual axes of an AVI-600.

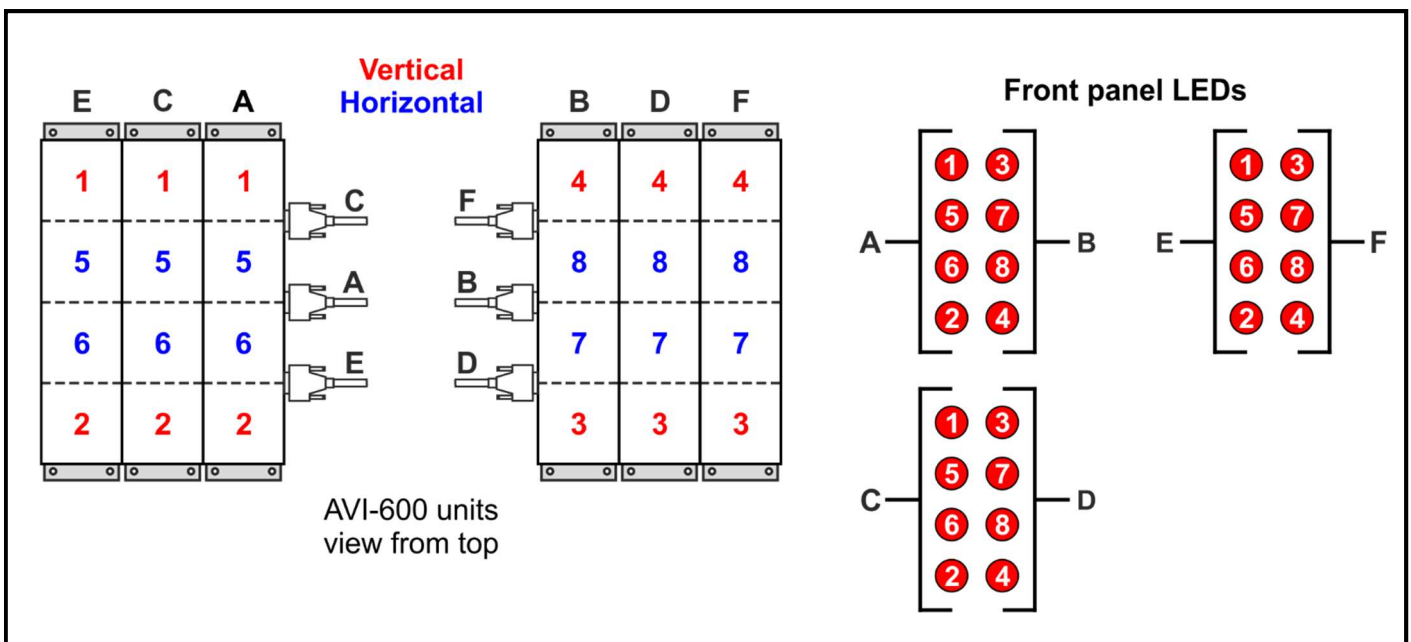

Installation checklist

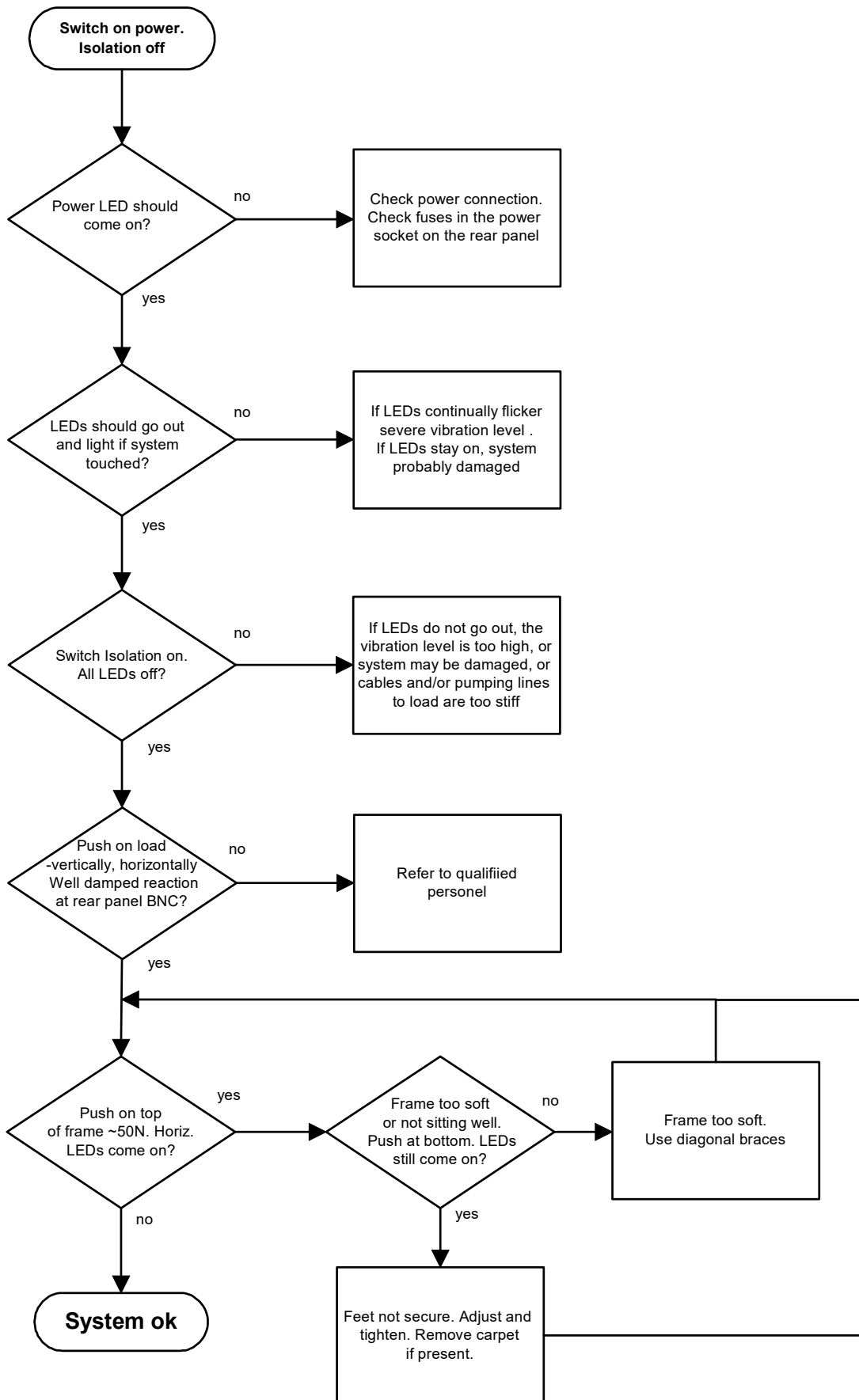

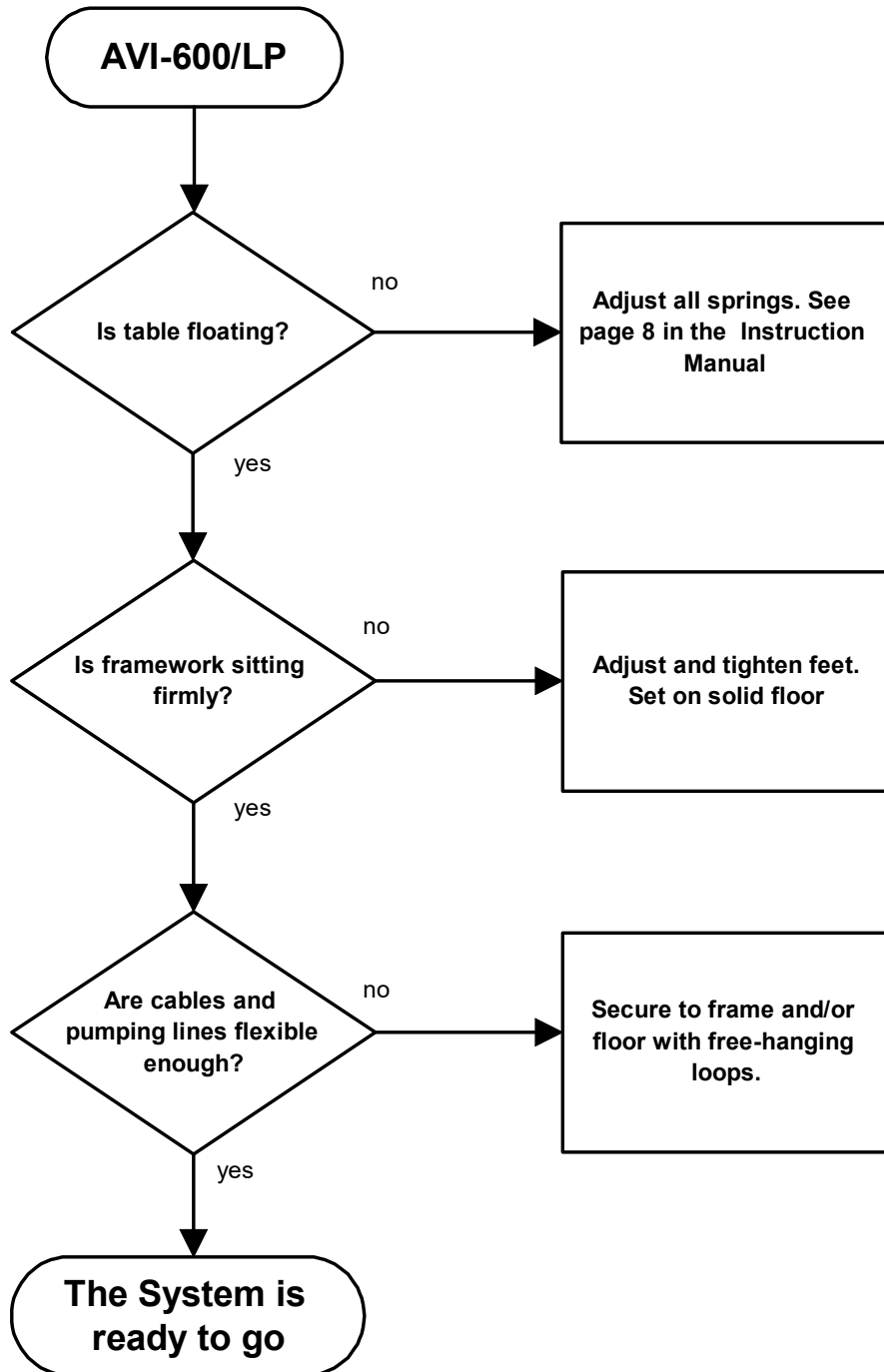

Vertical

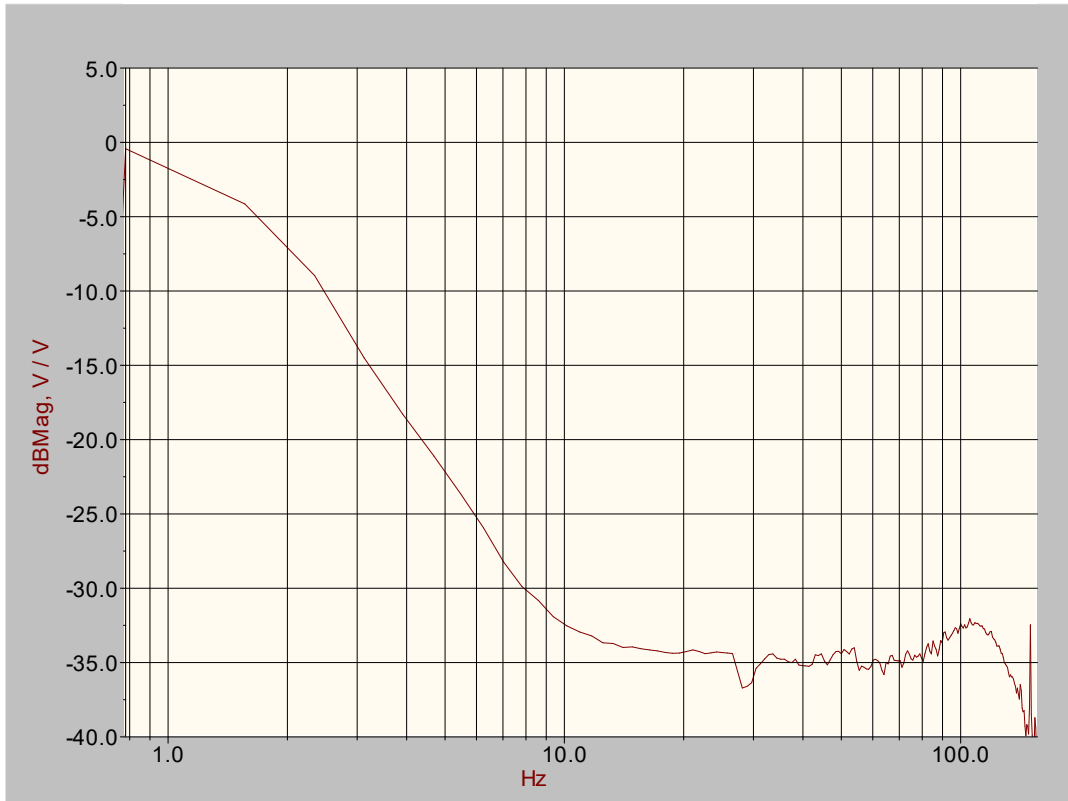

Horizontal

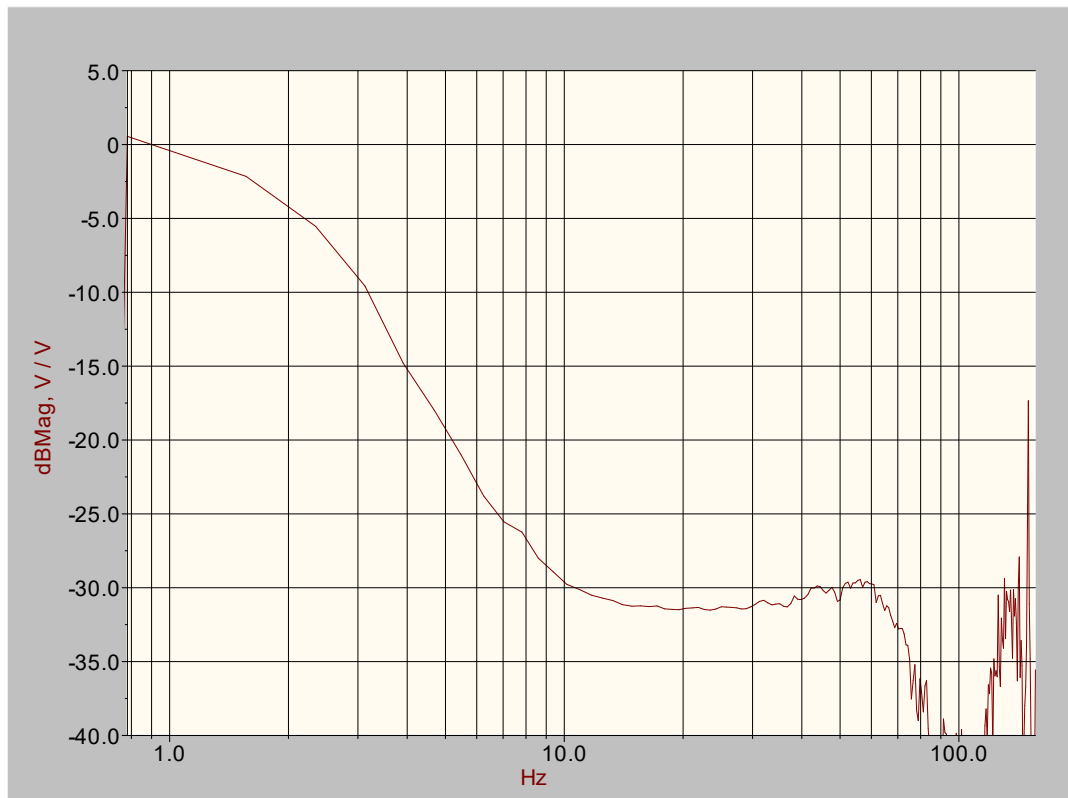

Dimensions AVI-600S LP

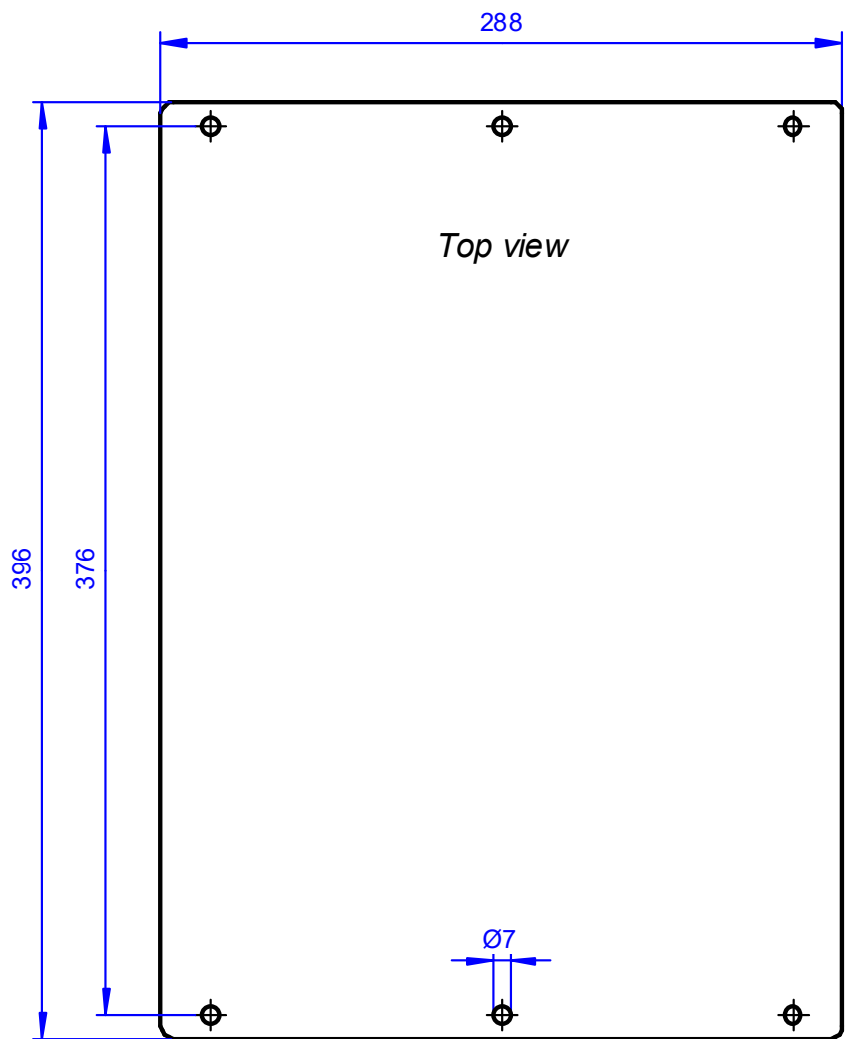
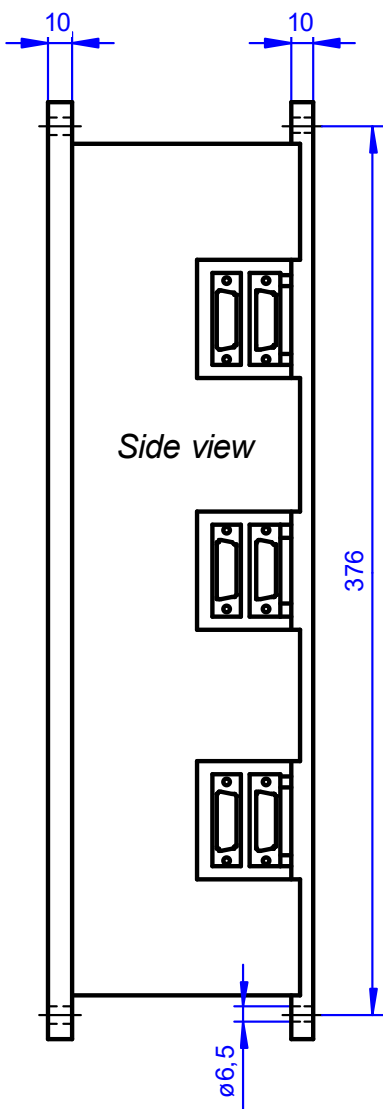
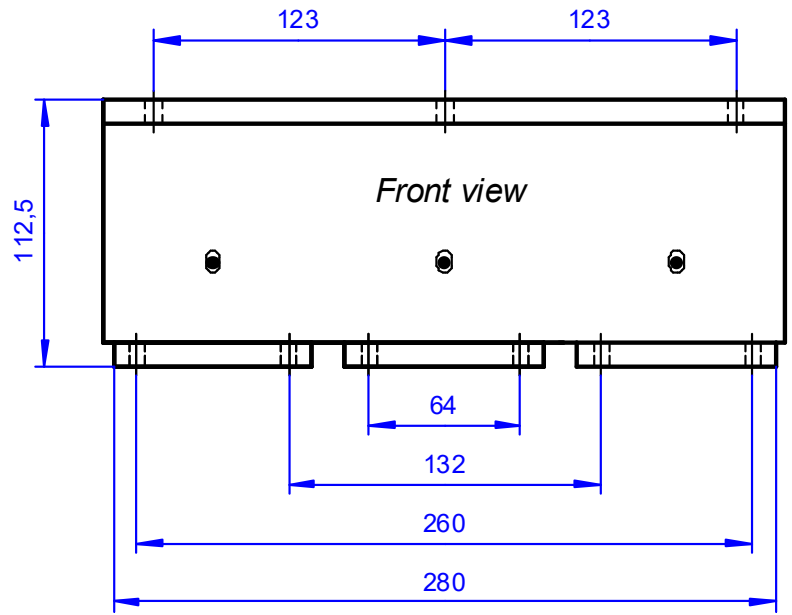

Dimensions AVI-600M LP

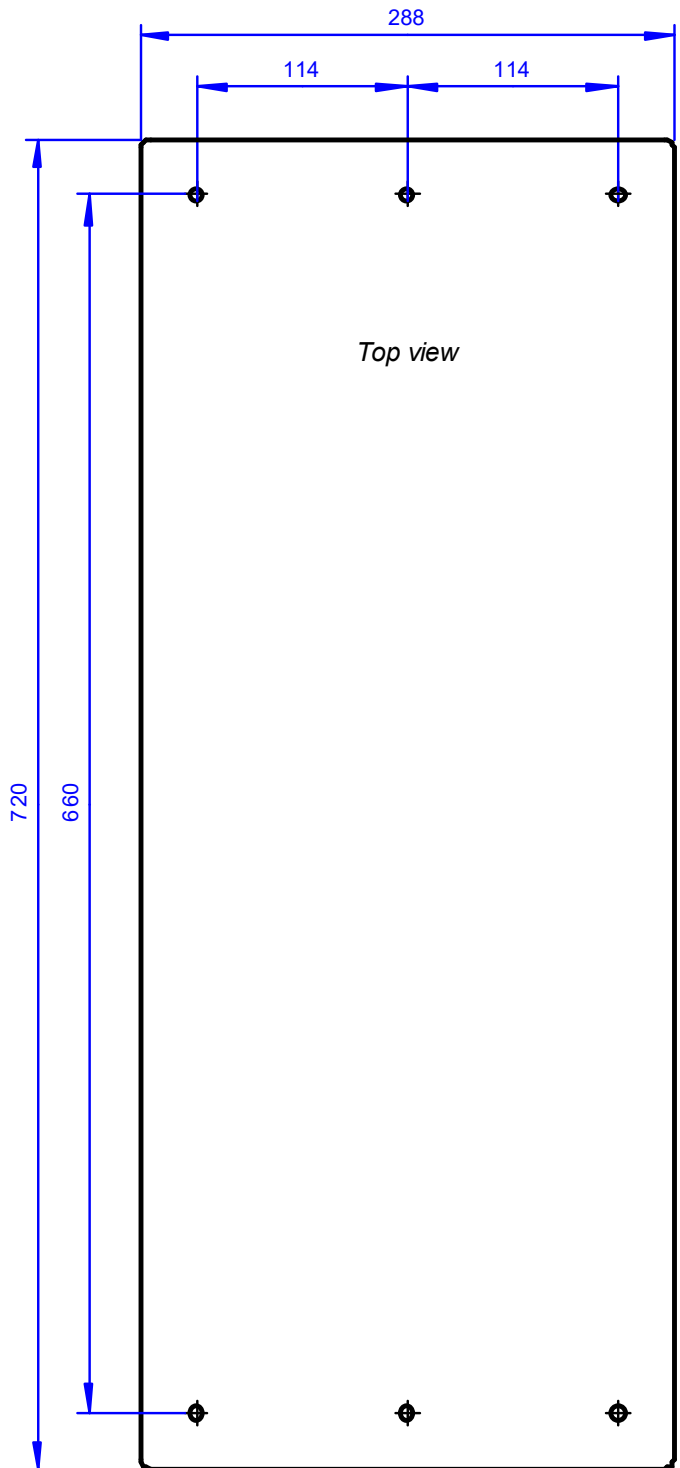
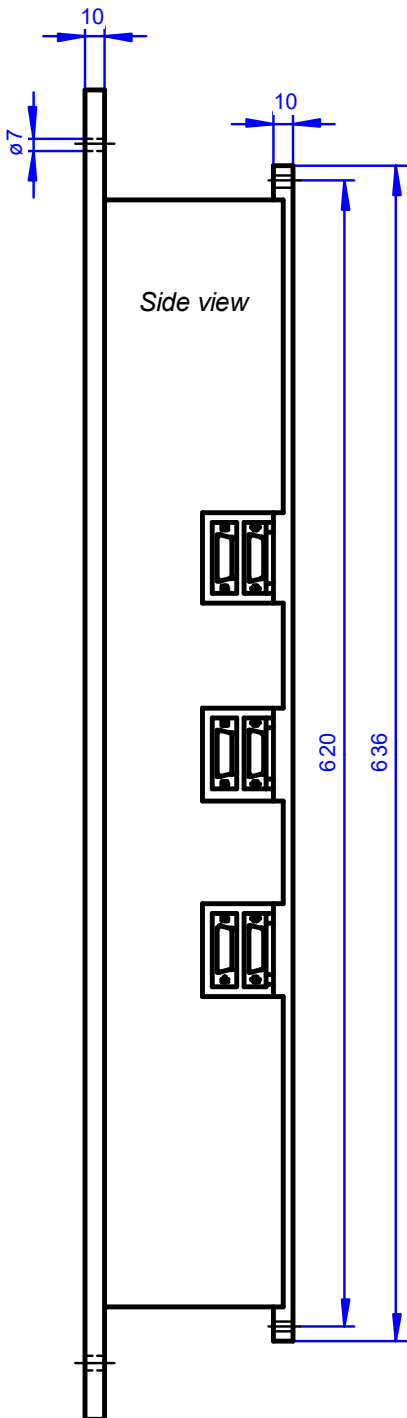
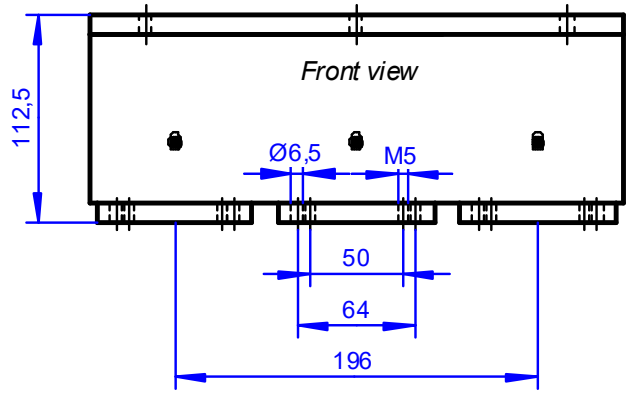

Dimensions AVI-600XL LP

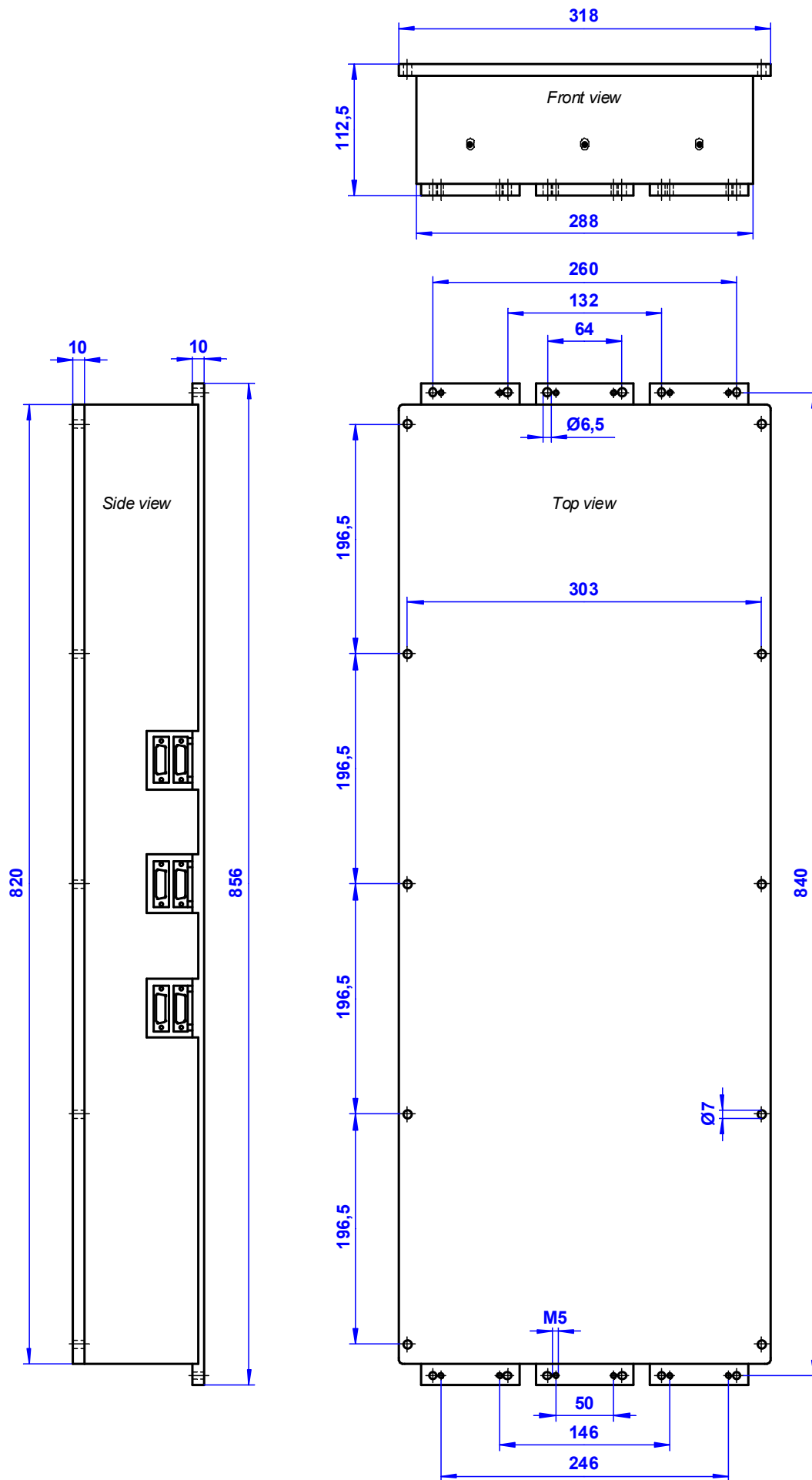

Optional accessories

Remote control box RC-1

Art. No. 4040

A remote control box can be connected to the remote D-Sub socket on the rear and allows you to switch the Isolation on and off externally.



Modulation Input box MB-3





Art. No. 4053

The modulation box allows an excitation signal to be applied to a TS Isolation system so that the system may be used as a shaker in any direction. The modulation is applied to the isolated TS system so that external vibrations are avoided. Different excitation directions can be selected.

There is no separate power supply or signal generator required.



Sales offices

<p>Geographical Europe near and middle East Africa India</p>		<p>HWL Scientific Instruments Im Hölderle 9 72070 Tübingen Germany Phone: +49 7073 85 21 812 Fax: +49 7073 85 21 810 E-mail: info@hwlsscientific.com Internet: www.hwlsscientific.com</p>
<p>Americas Australia New Zealand</p>		<p>HERZAN LLC 23042 Alcalde Drive, Suite D Laguna Hills, Ca 92653 USA Phone: +1 949 363 2905 Fax: +1 949 340 9751 E-mail: sales@herzan.com Internet: www.herzan.com</p>
<p>Asia</p>		<p>HERZ CO LTD. 7/F., Pacific Marks Yokohama East 3-4, Sakae-cho, Kanagawa-ku Yokohama, 221-0052 Japan Phone: +81 45 450 2211 Fax: +81 45 450 2221 E-mail: sales@herz-f.co.jp Internet: www.herz-f.co.jp</p>
<p>ASEAN countries China (including Hong Kong)</p>		<p>OCTALAB 83 Bukit Drive, #05-07 Singapore 587849 Phone: +65 961 81 268 E-mail: enquiry@octalab.com Internet: www.octalab.com</p>

Service order

If you suspect that a fault has developed in your isolation system, please fill in the service order form which you can download from our website: www.tablestable.com and send by fax/email to the address below. Our service department will contact you by return. If it proves to be necessary to return the system for repair, you will be issued with an **RMA number** which should then appear on all shipping documents

The Table Stable Ltd.
Im Grindel 6
8932 Mettmenstetten
Switzerland

Phone: +41 (0)44 776 33 66
Fax: +41 (0)44 776 33 65
E-mail: info@tablestable.com
Internet: www.tablestable.com

Specifications AVI-600 LP

<i>Isolation technology:</i>	Highly sensitive piezoelectric sensors in combination with fast and low power consumption force-motors
<i>Correction directions:</i>	Active Isolation against all six translational and rotational vibration modes
<i>Isolation:</i>	dynamic 1 Hz to 200 Hz, passive beyond 200 Hz.
<i>Transmissibility:</i>	see transmission curve. Above 10 Hz transmissibility <0.017 decreasing rapidly beyond 100 Hz, depending on load.
<i>Correction Forces:</i>	maximum 12N horizontally, 24N vertically
<i>System Noise:</i>	less than 50nG/√Hz from 0.1 – 200 Hz in any direction
<i>Static Load:</i>	minimum 0 kg maximum 600 kg on each element
<i>Static Compliance:</i>	approx. 1 μm/N vertically, 2 μm/N horizontally
<i>Weight per unit:</i>	AVI-600 S: 22.5 kg AVI-600 M: 29.0 kg AVI-600 XL: 33.8 kg

Control Unit

<i>Input Voltage:</i>	100-120/200-240 VAC, 50-60Hz
<i>Power Consumption:</i>	typically 28 W
<i>Fuses:</i>	2×1.6A/250V slow
<i>Safety Class:</i>	1
<i>Protection class:</i>	IP 20
<i>Overload Indication:</i>	24 LEDs indicate overload condition in output stage.
<i>Monitor Signal:</i>	A multiplexed signal for display on oscilloscope shows vibration levels of 8 axes with and without isolation.
<i>Temperature range:</i>	5° - 40°C / 41°-104°F
<i>Relative humidity:</i>	10 – 90% (5° – 30°C / 41°-86°F) 10 – 60% (30° – 40°C / 86°-104°F)
<i>Application:</i>	Indoor
<i>Altitude:</i>	up to 2000m (6500ft)

Technical details of the data, design and illustrations provided in these guidelines are subject to change without notice.